

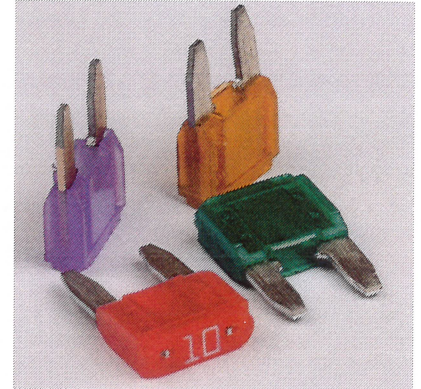

PROTECTRON ELECTROMECH (P) LTD

DESCRIPTION : MINI BLADE FUSE – STANDARD PLUG IN TYPE 58V

PART NO: PTF 600 In
(REFER TABLE)



ELECTRICAL PARAMETERS:

RATED VOLTAGE : DC 58V
INTERRUPTING RATING : 1000A @ 58V DC
COMPONENT LEVEL TEMPERATURE RANGE : -40°C TO +125°C
SYSTEM LEVEL TEMPERATURE RANGE : -40°C TO +105°C
105°C IS A TYPICAL SYSTEM LEVEL TEMPERATURE REQUIREMENTS

MATERIAL AND FINISH

BODY : NYLON (PA66)
ELEMENT : ZINC ALLOY, PLATED

PACKING DETAILS:

STANDARD : 500 No's BULK PACKING

CUSTOMIZED PACKING IS AVAILABLE BASED ON REQUEST



PROTECTRON ELECTROMECH (P) LTD





DESCRIPTION : MINI BLADE FUSE – STANDARD PLUG IN TYPE 58V

PART NO: PTF 600 In
(REFER TABLE)

ORDERING INFORMATION

PTF 600 In

In = NOMINAL CURRENT(2A TO 30A)

| PART NUMBERS | CURRENT RATING (A) | HOUSING MATERIAL COLOR | TYPICAL VOLTAGE DROP (mV) | TYPICAL COLD RESISTANCE(mΩ) | I ² t VALUE(A ² s) (TYPICAL) |
|--------------|--------------------|---|---------------------------|-----------------------------|--|
| PTF 600 2A | 2A | GRAY  | 171 | 55.60 | 2.6 |
| PTF 600 3A | 3A | VIOLET  | 153 | 33.75 | 08 |
| PTF 600 4A | 4A | PINK  | 121 | 23.48 | 16 |
| PTF 600 5A | 5A | TAN  | 129 | 17.75 | 23 |
| PTF 600 7.5A | 7.5A | BROWN  | 135 | 10.85 | 65 |
| PTF 600 10A | 10A | RED  | 108 | 7.42 | 88 |
| PTF 600 15A | 15A | BLUE  | 98 | 4.58 | 262 |
| PTF 600 20A | 20A | YELLOW  | 96 | 3.21 | 361 |
| PTF 600 25A | 25A | NATURAL  | 86 | 2.36 | 600 |
| PTF 600 30A | 30A | GREEN  | 87 | 1.85 | 1073 |

MARKINGS ON THE INSULATOR SHOULD BE AS FOLLOWS:-

'AMPERAGE', 'VOLTAGE RATING' AND 'PROTECTRON' (MANUFACTURER)

ELECTRICAL CHARACTERISTICS:-

| % OF AMPERE RATING | AMPERE RATING | OPENING TIME |
|--------------------|---------------|-----------------------------|
| 110% | 2-30Amp | 100 Hours Min. |
| 135% | 2-30Amp | 750msec. Min.; 600sec. Max. |
| 160% | 2-30Amp | 250msec. Min.; 50sec. Max. |
| 200% | 2-30Amp | 150msec. Min.; 5sec. Max. |
| 350% | 2-30Amp | 80msec. Min.; 500msec. Max. |
| 600% | 2-30Amp | 30msec. Min; 100msec. Max. |



PROTECTRON ELECTROMECH (P) LTD

DESCRIPTION : MINI BLADE FUSE – STANDARD PLUG IN TYPE 58V

PART NO: PTF 600 In
(REFER TABLE)

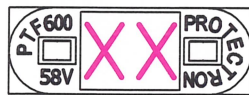
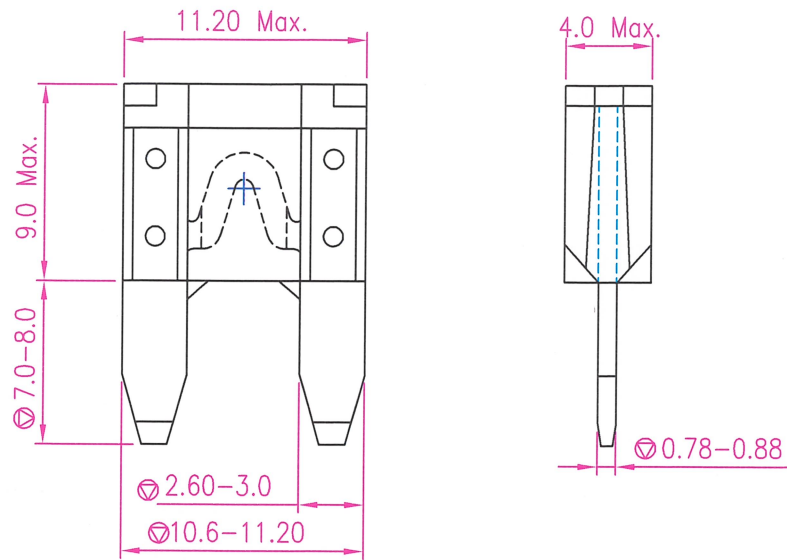

TEMPERATURE RERATING CURVE

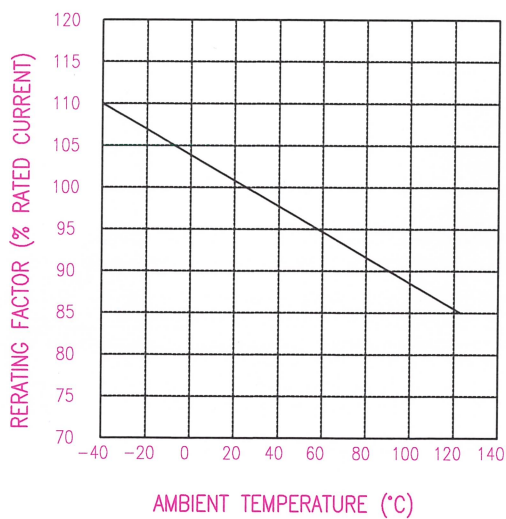

TIME-CURRENT CHARACTERISTIC CURVES

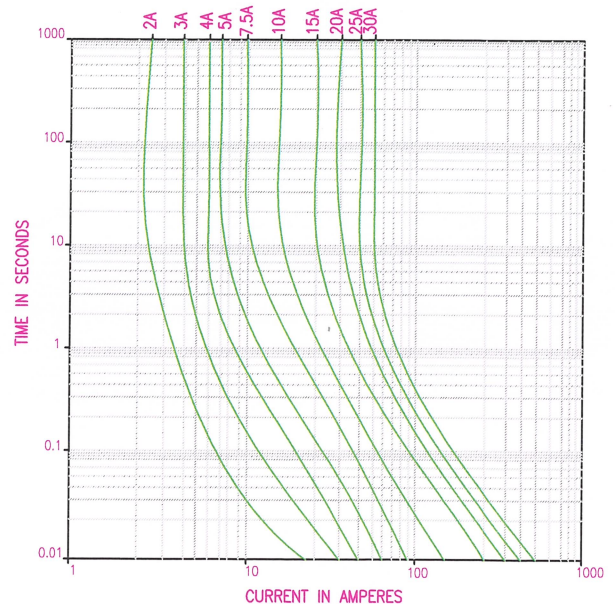

| | | | | | | |
|------|----------|-------------|------------|---------------|--------------|----------|
| A | ORIGINAL | GEETHA | 04.10.2019 | <i>Geetha</i> | <i>Barth</i> | |
| REV. | | DESCRIPTION | DRN. BY | DATE | CK'ED BY | APP'D BY |



Scale: NTS

Sht. Size: A4

Gen. Tol.: ±0.25mm
±2°

ALL DIMENSIONS ARE IN MM.
IF UNLESS OTHERWISE SPECIFIED.