



**DESCRIPTION** : MINI BLADE FUSE – STANDARD PLUG IN TYPE 58V

**PART NO:** PTF 600 In  
(REFER TABLE)

RoHS



**ELECTRICAL PARAMETERS:**

RATED VOLTAGE : DC 58V  
INTERRUPTING RATING : 1000A @ 58V DC  
COMPONENT LEVEL TEMPERATURE RANGE : -40°C TO +125°C  
SYSTEM LEVEL TEMPERATURE RANGE : -40°C TO +105°C  
105°C IS A TYPICAL SYSTEM LEVEL TEMPERATURE REQUIREMENTS

**MATERIAL AND FINISH**

BODY : NYLON (PA66)  
ELEMENT : ZINC ALLOY, Sn PLATED

**PACKING DETAILS:**

STANDARD : 500 No's BULK PACKING  
CUSTOMIZED PACKING IS AVAILABLE BASED ON REQUEST













**DESCRIPTION :** MINI BLADE FUSE – STANDARD PLUG IN TYPE 58V

**PART NO:** PTF 600 In  
(REFER TABLE)

**ORDERING INFORMATION**

**PTF 600 In**

In = NOMINAL CURRENT(2A TO 30A)

PART NUMBERS	CURRENT RATING (A)	HOUSING MATERIAL COLOR	TYPICAL VOLTAGE DROP (mV)	TYPICAL COLD RESISTANCE(mΩ)	I <sup>2</sup> t VALUE(A <sup>2</sup> s) (TYPICAL)
PTF 600 2A	2A	GRAY 	171	55.60	2.6
PTF 600 3A	3A	VIOLET 	153	33.75	08
PTF 600 4A	4A	PINK 	121	23.48	16
PTF 600 5A	5A	TAN 	129	17.75	23
PTF 600 7.5A	7.5A	BROWN 	135	10.85	65
PTF 600 10A	10A	RED 	108	7.42	88
PTF 600 15A	15A	BLUE 	98	4.58	262
PTF 600 20A	20A	YELLOW 	96	3.21	361
PTF 600 25A	25A	NATURAL 	86	2.36	600
PTF 600 30A	30A	GREEN 	87	1.85	1073

**MARKINGS ON THE INSULATOR SHOULD BE AS FOLLOWS:-**

'AMPERAGE', 'VOLTAGE RATING' AND 'PROTECTRON' (MANUFACTURER)

**ELECTRICAL CHARACTERISTICS:-**

% OF AMPERE RATING	AMPERE RATING	OPENING TIME
110%	2-30Amp	100 Hours Min.
135%	2-30Amp	750msec. Min.; 600sec. Max.
160%	2-30Amp	250msec. Min.; 50sec. Max.
200%	2-30Amp	150msec. Min.; 5sec. Max.
350%	2-30Amp	80msec. Min.; 500msec. Max.
600%	2-30Amp	30msec. Min; 100msec. Max.



**DESCRIPTION :** MINI BLADE FUSE – STANDARD PLUG IN TYPE 58V

**PART NO:** PTF 600 In  
(REFER TABLE)

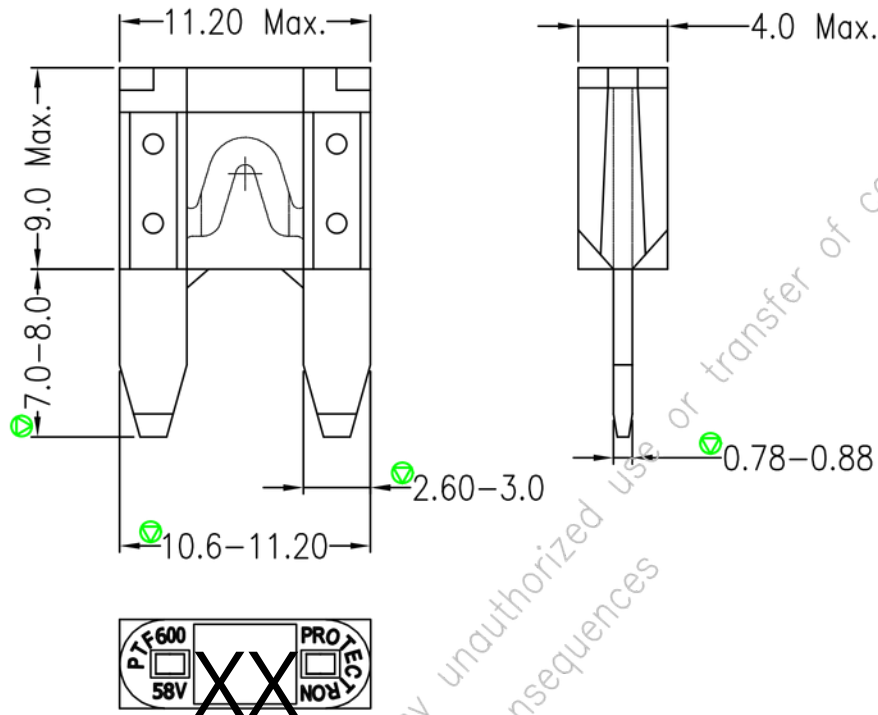

**TIME-CURRENT CHARACTERISTIC CURVES**

**TEMPERATURE DERATING CURVE**

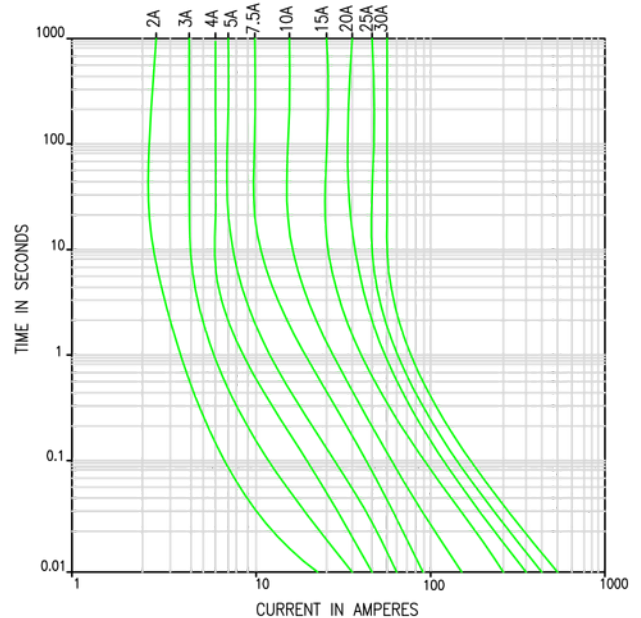
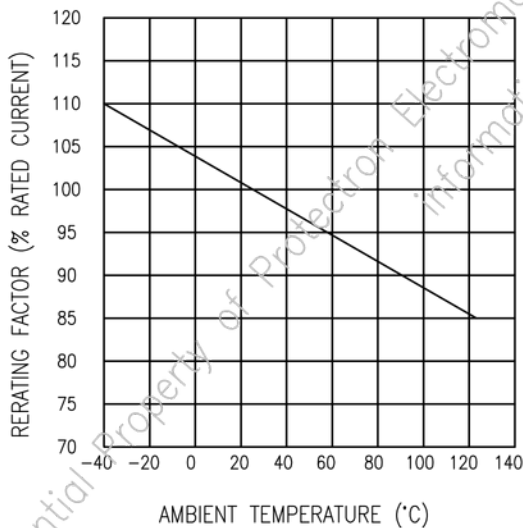

Projection:



Scale: NTS

Sht. Size: A4

Gen. Tol.: ±0.25mm  
±2°

ALL DIMENSIONS ARE IN MM.  
IF UNLESS OTHERWISE SPECIFIED.