

DESCRIPTION :TERMINAL BLOCK HEADER, WITH SIDE LOCKING SCREWS (SCREW TYPE)

PART NO:PTB2EDGXM-XX-XXP-1X-00  
 1st X=PCB MOUNTING  
 2nd XX=PITCH  
 3rd XX=NO. OF CONTACTS  
 4th X=COLOR

RoHS



**PHYSICAL DATA**

MATERIAL : THERMOPLASTIC(UL94V-0)  
 CONTACT : COPPER ALLOY, TIN PLATED  
 FLANGE NUT : BRASS, M2.5  
**PACKAGING TYPE** : BULK PACKING

**ELECTRICAL DATA**

**RATED CURRENT** : 12A  
**INSULATION RESISTANCE** : 5000M OHMS MIN  
**DIELECTRIC VOLATGE** : 1600V AC/MIN  
**CONTACT RESISTANCE** : 20m OHMS MAX  
**VOLTAGE RATING** : 300V

**ENVIRONMENTAL DATA**

**TEMPERATURE RANGE** : -40° TO +105°C



# PROTECTRON ELECTROMECH (P) LTD

DESCRIPTION : TERMINAL BLOCK HEADER, WITH SIDE LOCKING SCREWS (SCREW TYPE)

PART NO: PTB2EDGXM-XX-XXP-1X-00  
 1st X=PCB MOUNTING  
 2nd XX=PITCH  
 3rd XX=NO. OF CONTACTS  
 4th X=COLOR

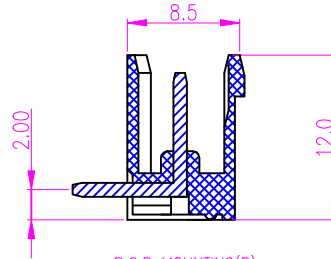
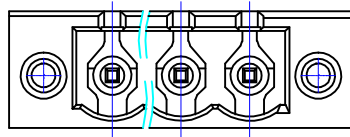

P.C.B MOUNTING(R)

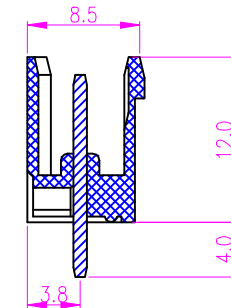
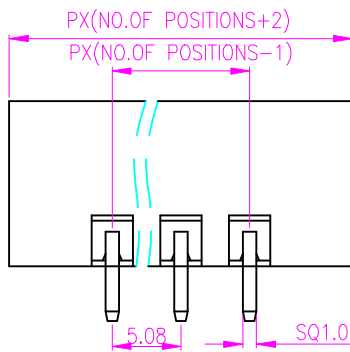

P.C.B MOUNTING(V)

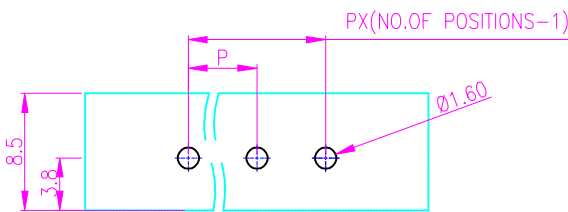

RECOMMENDED PCB LAYOUT(V)

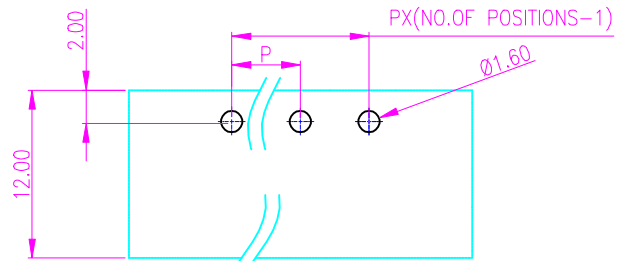

RECOMMENDED PCB LAYOUT(R)

## ORDERING INFORMATION

PTB2EDGXM-XX-XXP-1X-00

PCB MOUNTING V- VERTICAL R- RIGHTANGLE	PITCH 5.0 5.08 10.0 10.16	NO OF CONTACTS 02~24(PITCH5.0/5.08) 02~12(PITCH10.0/10.16) (SOLID BLOCK)	COLOR 0=BLACK 5=GREEN 6=BLUE 8=GREY
--	---------------------------------------	---	---

**PROVISIONAL**

A	ORIGINAL	SUJATHA	05.06.2013		
REV.	DESCRIPTION	DRN. BY	DATE	CK'ED BY	APP'D BY

Projection: 	Scale: NTS	Sht. Size: A4	Gen. Tol.: ±0.5mm ±0.2'	ALL DIMENSIONS ARE IN MM. IF UNLESS OTHERWISE SPECIFIED.
-----------------	------------	---------------	----------------------------	---

DESCRIPTION :TERMINAL BLOCK PLUGGABLE TYPE

PART NO:PTB2EDGXM-XX-XXP-1X-00  
1st X=PCB MOUNTING  
2nd XX=PITCH  
3rd XX=NO. OF CONTACTS  
4th X=COLOR

RoHS



### PHYSICAL DATA

#### INSULATION

MATERIAL : THERMOPLASTIC(UL94V-0)

#### CONTACT

MATERIAL : COPPER ALLOY, TIN PLATED

#### PACKAGING TYPE

: BULK PACKING

### ELECTRICAL DATA

RATED CURRENT : 12A

VOLTAGE RATING : 300V

WITHSTANDING VOLTAGE : 1.6KV

### ENVIRONMENTAL DATA

TEMPERATURE RANGE : -40° TO +105°C

DESCRIPTION :TERMINAL BLOCK PLUGGABLE TYPE

PART NO:PTB2EDGXM-XX-XXP-1X-00  
 1st X=PCB MOUNTING  
 2nd XX=PITCH  
 3rd XX=NO. OF CONTACTS  
 4th X=COLOR

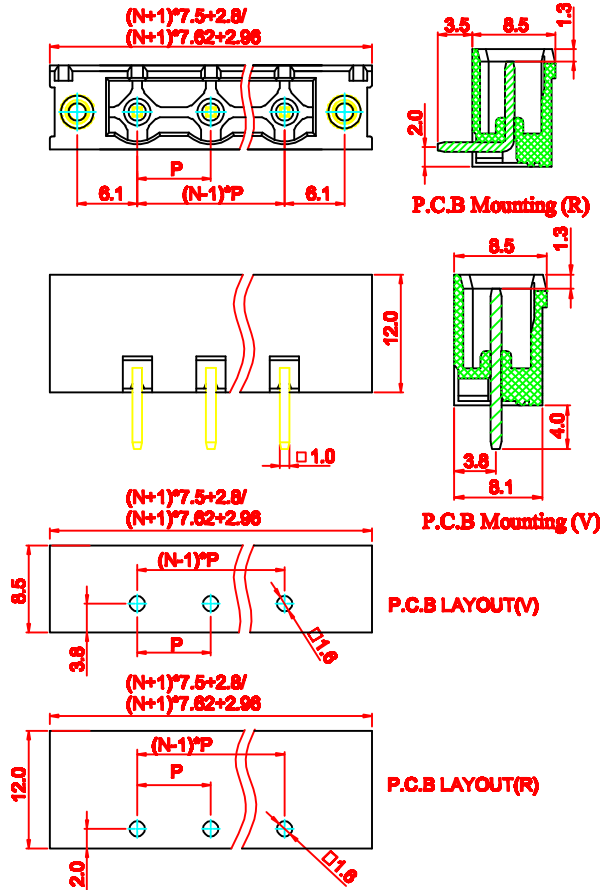

## ORDERING INFORMATION

PTB2EDGXM-XX-XXP-1X-00

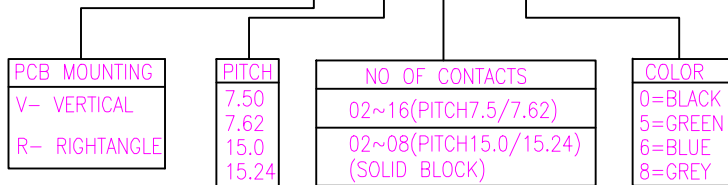

A	ORIGINAL				
REV.		DESCRIPTION	DRN. BY	DATE	CK'ED BY APP'D BY
	Projection: 	Scale: NTS	Sht. Size: A4	Gen. Tol.: ±0.5mm ±0.2'	ALL DIMENSIONS ARE IN MM. IF UNLESS OTHERWISE SPECIFIED.