



PROTECTRON ELECTROMECH (P) LTD

DESCRIPTION : MALE PIN 1mm PCB MOUNTING NON-INSULATED

P8003-00-1X-S
X=PLATING

RoHS



PHYSICAL

CONTACT : BRASS, SILVER OR GOLD PLATED
PACKAGING TYPE : BULK PACKING

ELECTRICAL

CURRENT RATING : 5A
CONTACT RESISTANCE : 5m OHMS MAX

MECHANICAL DATA

MOUNTING HOLE DIA IN PCB : ϕ 1.25mm

ENVIRONMENTAL DATA

TEMPERATURE RANGE : -65°C TO +125°C



PROTECTRON ELECTROMECH (P) LTD

DESCRIPTION : MALE PIN 1mm PCB MOUNTING NON-INSULATED

P8003-00-1X-S
X=PLATING

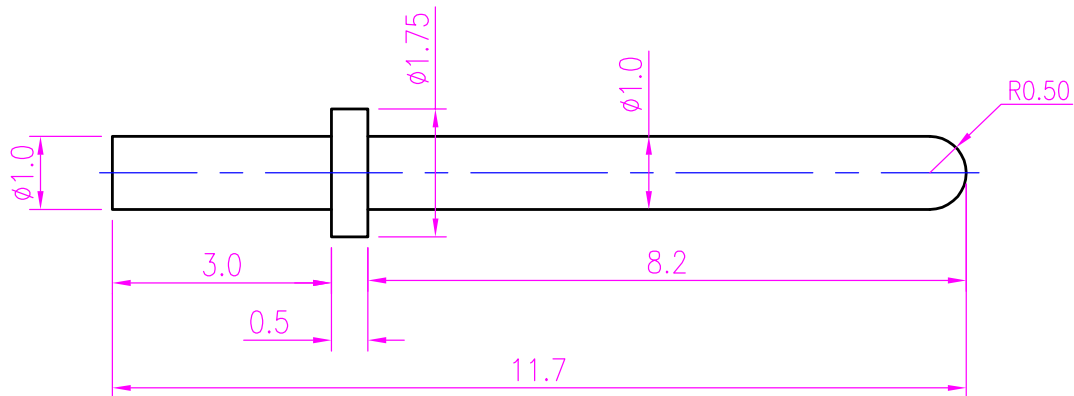

MATING CONNECTORS

P8001 P8002
P8101 P8102
P8202

ORDERING INFORMATION

P8003-00-1X-S

PLATING	X
SILVER PLATING	1
GOLD PLATING	2

MOQ- 2500 MIN
SPQ- 2500 PER PACK

A	ORIGINAL	SACHIN	18.06.2003		
REV.	DESCRIPTION		DRN BY	DATE	CK'ED BY APP'D BY

Projection:

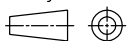

Scale: NTS

Sht. Size: A4

Gen. Tol.: ± 0.35 mm

ALL DIMENSIONS ARE IN MM.
IF UNLESS OTHERWISE SPECIFIED.



PROTECTRON ELECTROMECH (P) LTD

DESCRIPTION : MALE PIN 1mm PCB MOUNTING NON-INSULATED
RIGHT ANGLE

P8003-00-1X-R
X=PLATING

RoHS

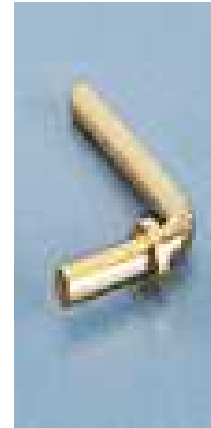

PHYSICAL

CONTACT : BRASS, GOLD/SILVER PLATED
PACKAGING TYPE : BULK PACKING

ELECTRICAL

CURRENT RATING : 5A
CONTACT RESISTANCE : 5m OHMS MAX

MECHANICAL DATA

MOUNTING HOLE DIA IN PCB : ϕ 1.25mm

ENVIRONMENTAL DATA

TEMPERATURE RANGE : -65°C TO +125°C



PROTECTRON ELECTROMECH (P) LTD

DESCRIPTION : MALE PIN 1mm PCB MOUNTING NON-INSULATED
RIGHT ANGLE

P8003-00-1X-R
X=PLATING

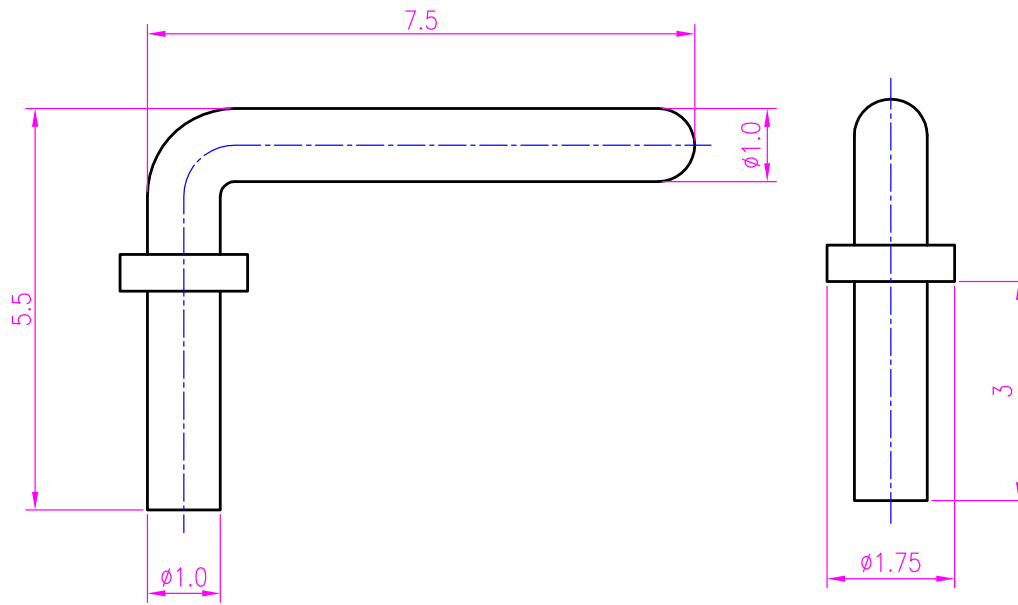

MATING CONNECTORS

P8001 P8002
P8101 P8102
P8202

ORDERING INFORMATION

P8003-00-1X-R

PLATING	X
SILVER PLATING	1
GOLD PLATING	2

MOQ- 2500 MIN
SPQ- 2500 PER PACK

A	ORIGINAL	CHETAN	23.08.2011		
REV.	DESCRIPTION		DRN BY	DATE	CKED BY APP'D BY

Projection:

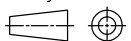

Scale: NTS

Sht. Size: A4

Gen. Tol.: ±0.2mm
±2°

ALL DIMENSIONS ARE IN MM.
IF UNLESS OTHERWISE SPECIFIED.



PROTECTRON ELECTROMECH (P) LTD

DESCRIPTION : MALE PIN 1mm PCB MOUNTING NON-INSULATED

P8003-00-1X-0
X=PLATING

RoHS



PHYSICAL

CONTACT : BRASS, SILVER OR GOLD PLATED
PACKAGING TYPE : BULK PACKING

ELECTRICAL

CURRENT RATING : 5A
CONTACT RESISTANCE : 5m OHMS Max

MECHANICAL DATA

MOUNTING HOLE DIA IN PCB : ϕ 1.25mm

ENVIRONMENTAL DATA

TEMPERATURE RANGE : -65°C TO +125°C



PROTECTRON ELECTROMECH (P) LTD

DESCRIPTION : MALE PIN 1mm PCB MOUNTING NON-INSULATED

P8003-00-1X-0
X=PLATING

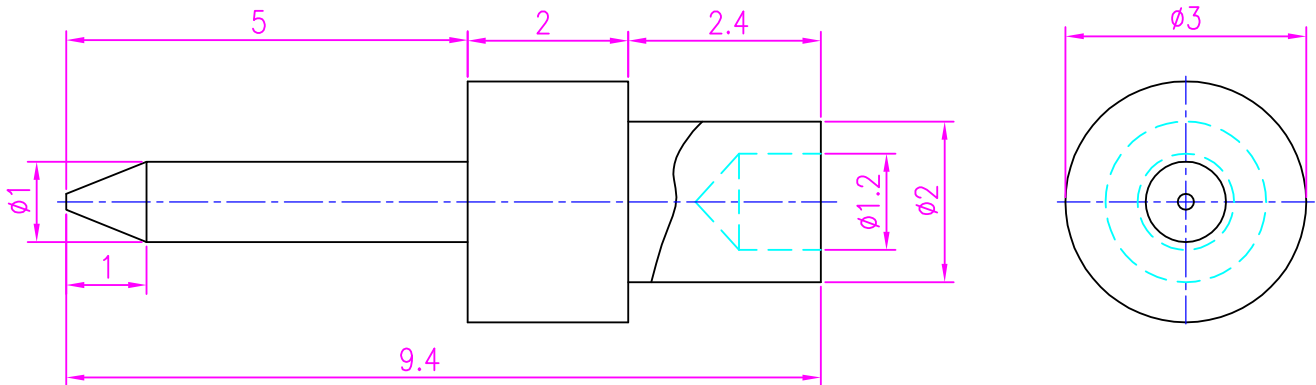

MATING CONNECTORS

P8001 P8002
P8101 P8102
P8202

ORDERING INFORMATION

P8003-00-1X-0

PLATING	X
SILVER PLATING	1
GOLD PLATING	2

MOQ- 2500 MIN

SPQ- 2500 PER PACK

A	ORIGINAL	CHAITRA	16.04.2008	
REV.	DESCRIPTION		BY	DATE
				APP'D BY

Projection:

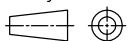

Scale: NTS

Sht. Size: A4

Gen. Tol.: ± 0.35 mm

ALL DIMENSIONS ARE IN MM.
IF UNLESS OTHERWISE SPECIFIED.

<http://www.protectron.in>

protectron@protectron.in