



# PROTECTRON ELECTROMECH (P) LTD

DESCRIPTION : MODULAR PLUG

PART NO: P7020X XX-X-X  
(SEE TABLE)

RoHS



## PHYSICAL

### MATERIAL

HOUSING	:	PC
FLAMMABILITY	:	UL 94V-2
COLOR	:	CLEAN
CONTACT	:	COPPER ALLOY, PLATED WITH GOLD
PACKAGING TYPE	:	BULK PACKING

## ELECTRICAL

TERMINATION RESISTANCE	:	35m OHMS MIN
DIELECTRIC WITHSTANDING	:	1000V AC
INSULATION RESISTANCE	:	500M $\Omega$
VOLTAGE RATING	:	125 VOLTS AC, AT 1.5 AMPS.
DURABILITY	:	750 CYCLES

## ENVIRONMENTAL DATA

TEMPERATURE RANGE	:	-40° TO +80° C
-------------------	---	----------------



# PROTECTRON ELECTROMECH (P) LTD

DESCRIPTION : MODULAR PLUG

PART NO: P7020X XX-X-X  
(SEE TABLE)

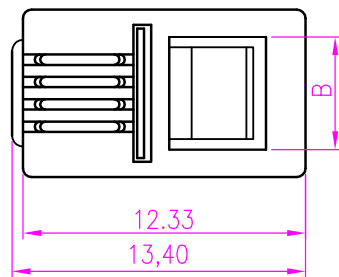
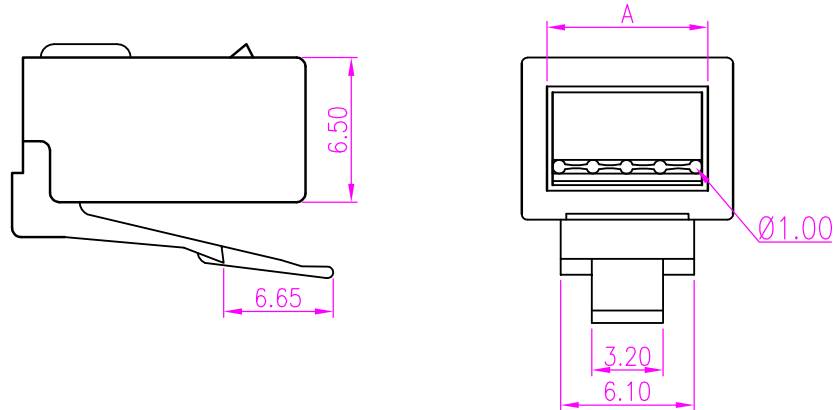

	A	B
6P2C	5.20	5.10
6P4C	5.20	5.10
6P6C	7.10	6.20

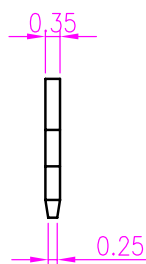
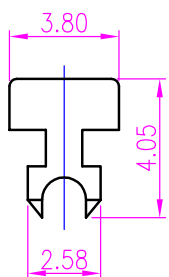

\* FOR STANDARD WIRE  
2 PRONGS CONTACT

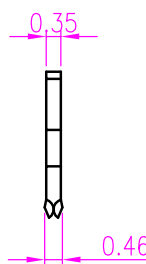
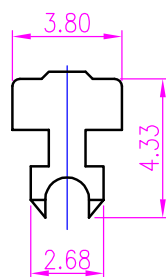

\* FOR SOLID WIRE  
2 PRONGS CONTACT

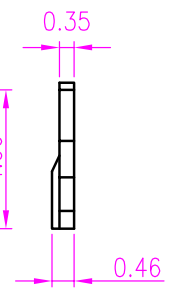
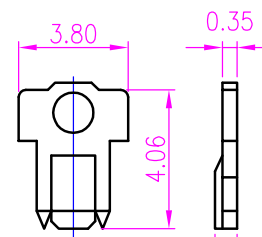

\* FOR SOLID WIRE  
3 PRONGS CONTACT

REV.	DESCRIPTION	DRN BY	DATE	CK'ED BY	APP'D BY
A	ORIGINAL	SACHIN	27.07.2007		

Projection: 	Scale: NTS	Sht. Size: A4	Gen. Tol.: ±0.3mm ±2°	ALL DIMENSIONS ARE IN MM. IF UNLESS OTHERWISE SPECIFIED.
-----------------	------------	---------------	--------------------------	---



# PROTECTRON ELECTROMECH (P) LTD

DESCRIPTION : MODULOR PLUG

PART NO:P7020X XX-X-X  
(SEE TABLE)

## ORDERING INFORMATION

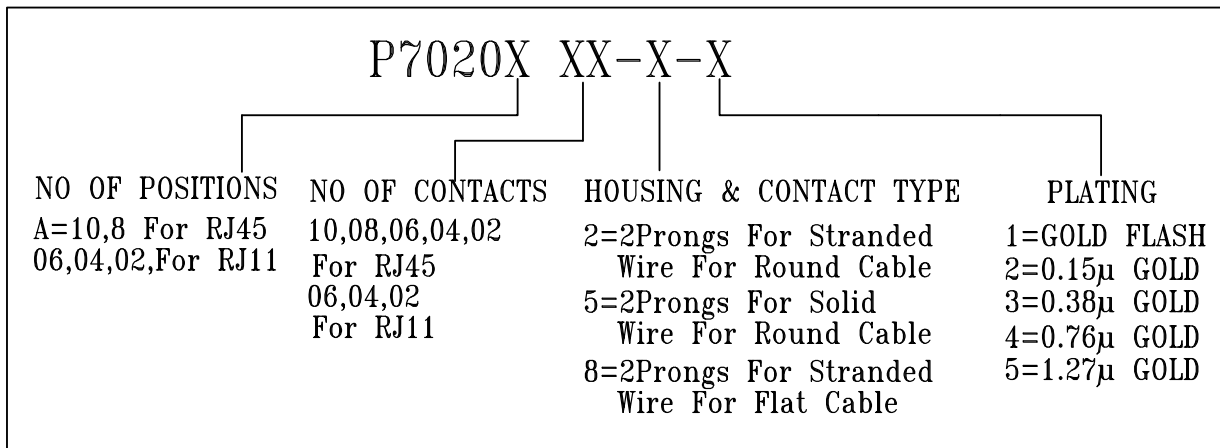

MOQ- ----

SPQ- ----